

Datasheet | VOS2000 lens series

Industrial-grade high-resolution C-mount lens of the VOS2000 series with broadband anti-reflection coating

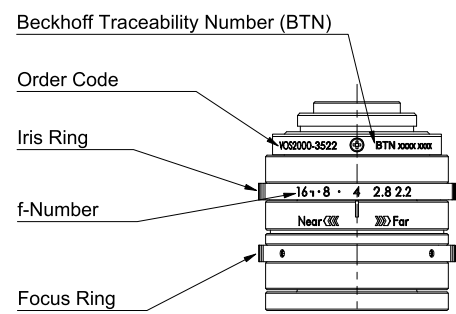

Basic data	Value
Focal length (mm)	35.0
Resolution (µm)	2
f-number	2.2 ... 16.0 (continuous)
Working distance (mm)	200 ... infinity
Image circle diameter (mm)	11
Largest suitable sensor	2/3" with 8.1 MP

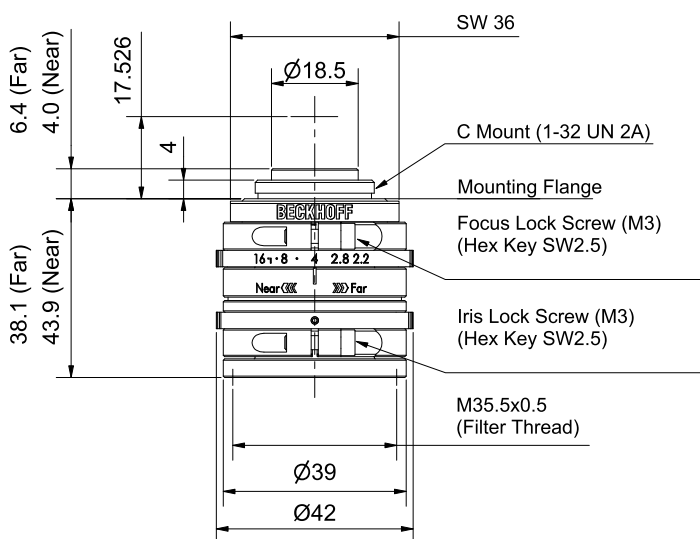

Mechanical data	Value
Total length (near - far) (mm)	44.5 ... 49.7
Length from lens shoulder (mm)	38.1 ... 43.9
Weight (g)	130
Diameter (mm)	42
Connection	C-mount
Filter thread	M35.5x0.5

Environmental conditions	Value
Vibration resistance ¹ (G)	10
Operating temperature ² (°C)	0 ... 60
Storage temperature ³ (°C)	-10 ... 60

¹ according to JISC60068-2-6 Freq. 10 - 150 [Hz], Test time: X,Y,X axis direction 20 cycles / 8 min total 160 min x 3 = 480 min.

² relative humidity 20 ... 70%, non-condensing

³ non-condensing

Optical data	Symbol	Nominal object distance	Minimum object distance
Working distance (mm)		500	200
Object distance ¹ (mm)	s	507.0	207.0
Focal length (mm)	f, f'	35.0	35.0
Object-side focal length (mm)	s_F	-2.63	-2.63
Image-side focal length (mm)	s'_F	14.75	18.16
Back focal length of the object-side principal plane (mm)	s_H	37.6	37.6
Back focal length of the image-side principal plane (mm)	s'_H	22.60	22.60
Interstitium (mm)	i	-26.22	-26.24
Distance from object to image (mm)		555.75	259.16
Object distance (mm)	a	544.6	244.6
Image distance (mm)	a'	37.4	40.8
f-number		2.2 ... 16.0	
Back focal length of the entrance pupil (mm)	s_{EP}	25.2	25.2
Back focal length of the exit pupil (mm)	s'_{AP}	41.8	41.8
Diameter of the entrance pupil (mm)		17.00	17.00
Diameter of the exit pupil (mm)		26.40	26.40
Angle of view ² (degrees)	ω_{\max}	17.88	17.88
Lateral magnification	β'	0.069	0.167
Distortion (%)		-0.09	-0.14
Depth of field ³ (mm)		35.5	6.3
Resolution ⁴ (μm)		2	
Relative illumination (%)		44.95	50.20
Image circle diameter (mm)		11	
Sensor size (inch)		2/3	
Flange focal length (mm)	$A_{O'}$	17.526	
Distance between object-side principal plane and lens shoulder (mm)	H_A	-6.38	-2.97
Available spectral range (nm)		420 ... 1050	

¹ identical with the *object distance* according to DIN 1335:2003-12

² identical with the double *object field angle* according to DIN 1335:2003-12

³ at a circle of confusion diameter of 0.04 mm

⁴ at 550 nm

Explanation of symbols

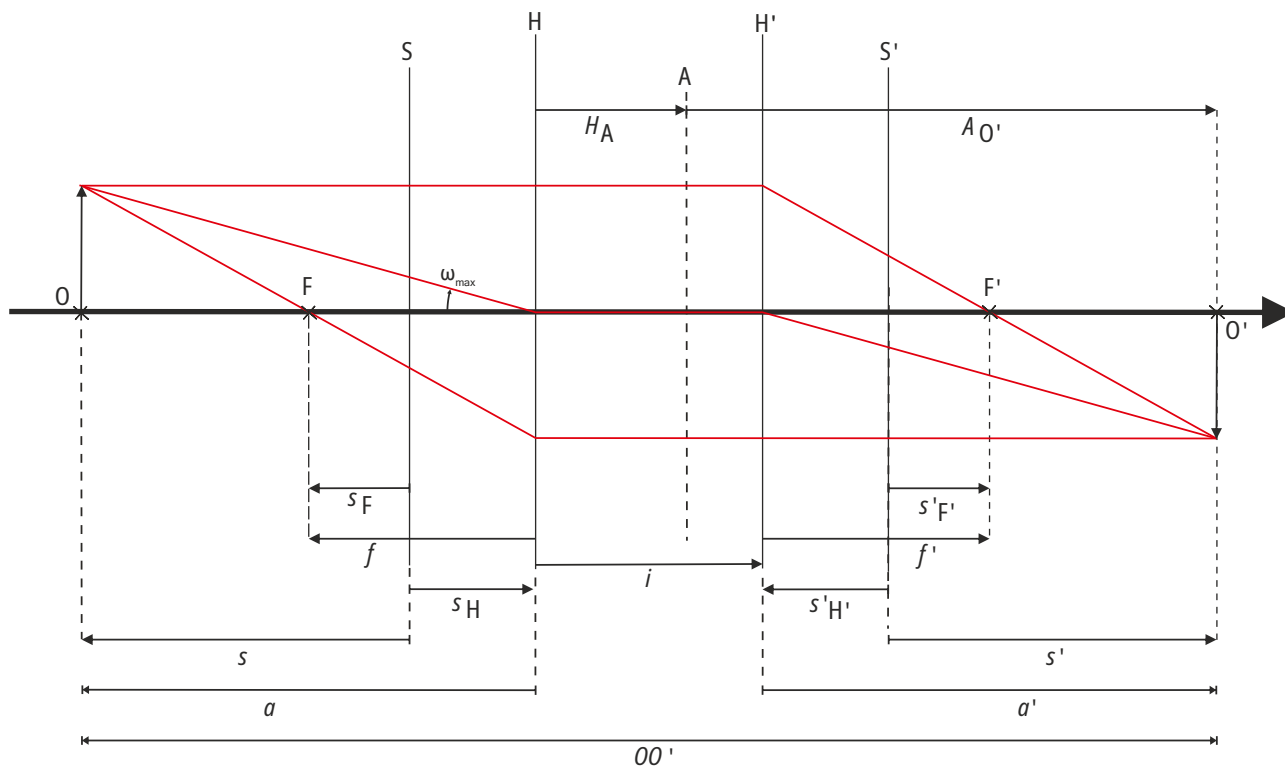

O	Axis point of the object	O'	Axis point of the image
F	object-side focal point	F'	image-side focal point
S	first vertex	S'	last vertex
H	object-side principal point	H'	image-side principal point
A	Lens shoulder	A _{O'}	Flange focal length
s_F	object-side back focal length	$s'_{F'}$	image-side back focal length
f	object-side focal length	f'	image-side focal length
s_H	Back focal length of the object-side principal point	$s'_{H'}$	Back focal length of the image-side principal point
s	Object distance	s'	Flange focal length
a	Object distance	a'	Image distance
H_A	Distance of the object-side principal point to the flange surface	i	Interstitium
ω_{\max}	object-side field angle	OO'	Distance of the axis points of object and image

Note: directional routes are indicated by arrows with an arrowhead.

Modulation transfer functions (MTF)

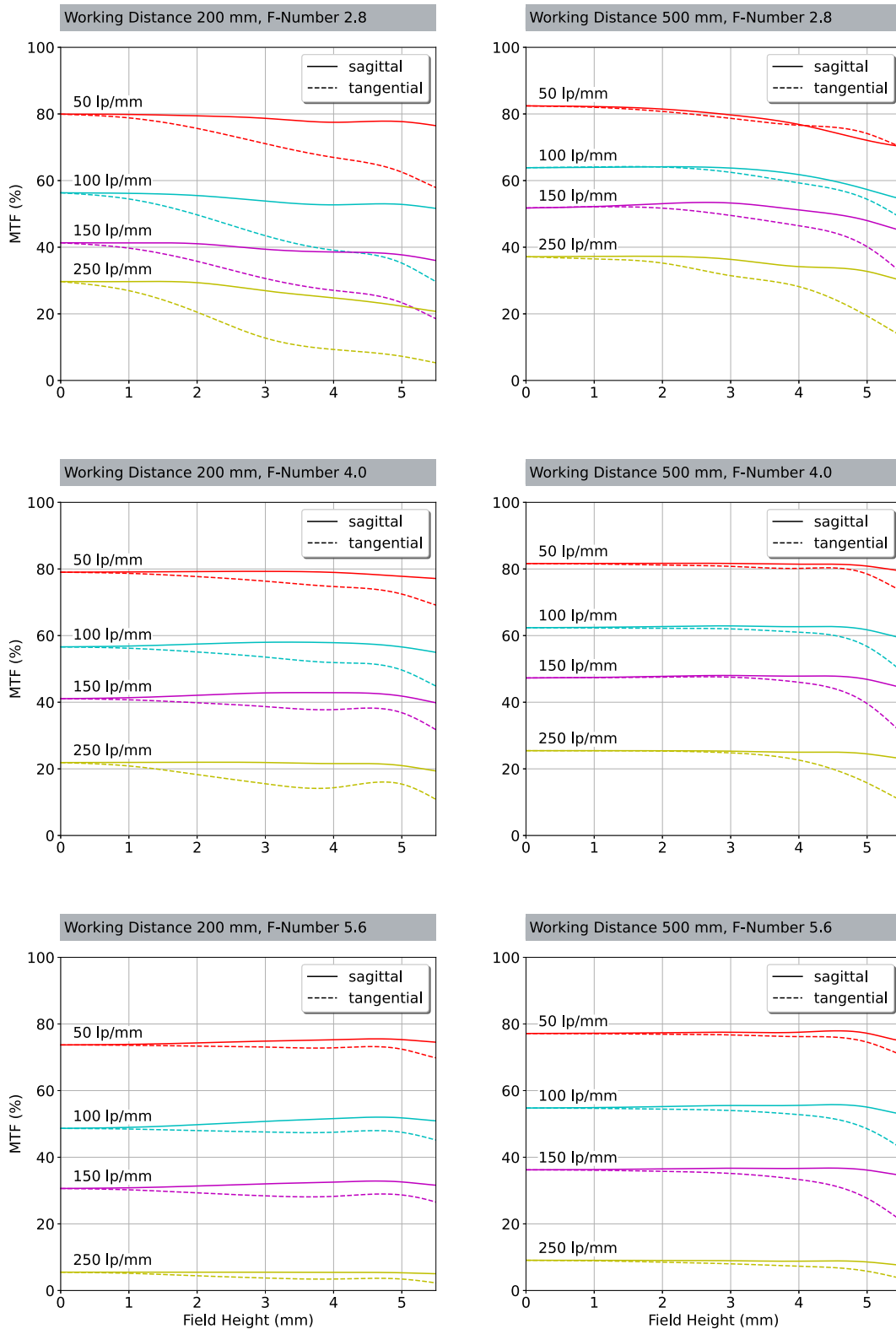

Distortion

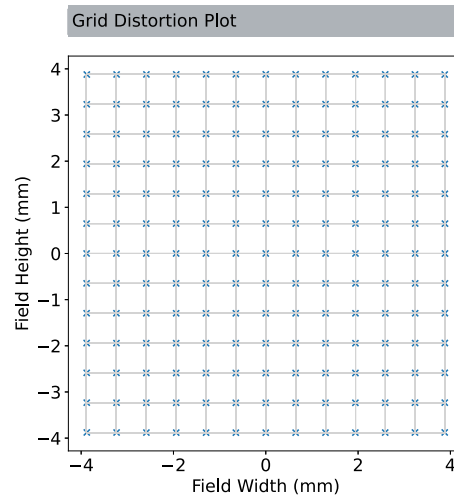
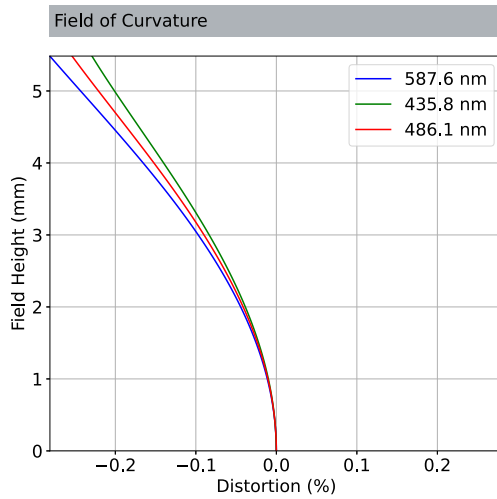

Relative illumination

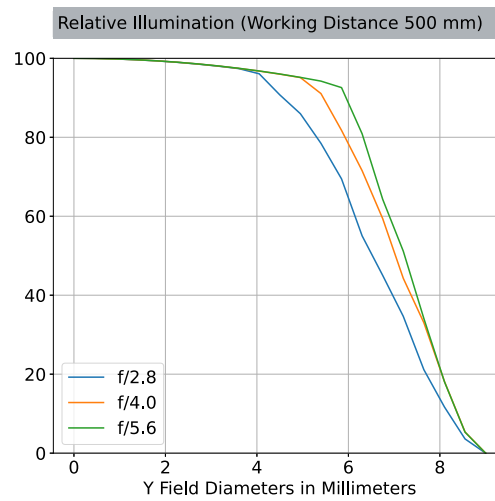
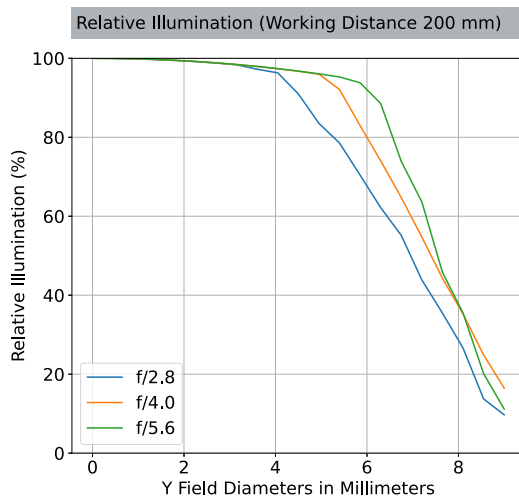

Transmission

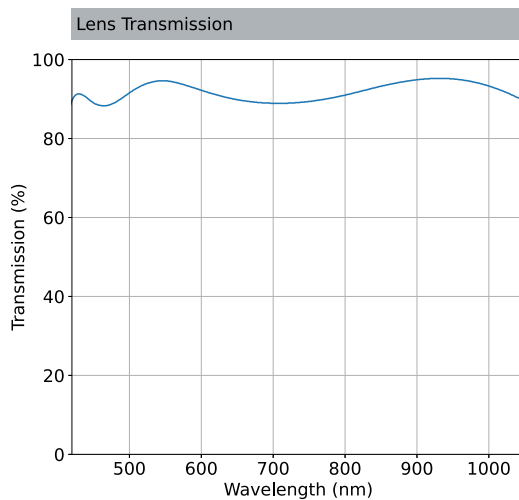

Beckhoff®, TwinCAT®, TwinCAT/BSD®, TC/BSD®, EtherCAT®, EtherCAT G®, EtherCAT G10®, EtherCAT P®, Safety over EtherCAT®, TwinSAFE®, XFC®, XTS® and XPlanar® are registered trademarks of and licensed by Beckhoff Automation GmbH. Other designations used in this publication may be trademarks whose use by third parties for their own purposes could violate the rights of the owners.

© Beckhoff Automation GmbH & Co. KG 11/10/2022

The information provided in this brochure contains merely general descriptions or characteristics of performance which in case of actual application do not always apply as described or which may change as a result of further development of the products. An obligation to provide the respective characteristics shall only exist if expressly agreed in the terms of contract.