

CP3913-0000  
with  
C9900-G029  
C9900-M390  
C9900-E274

main dimensions and  
fixing points

dimensions in mm

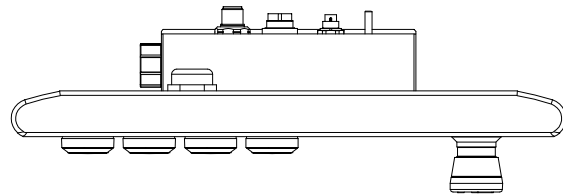
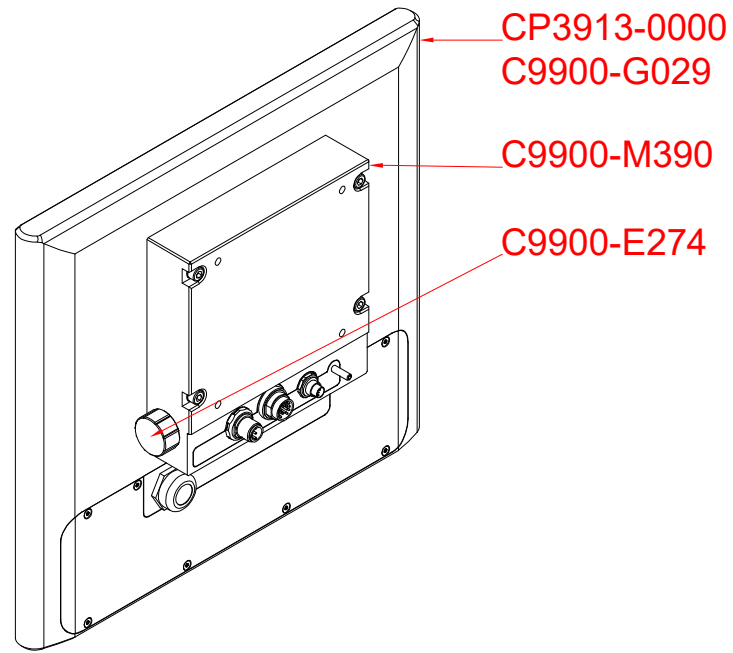

bottom view

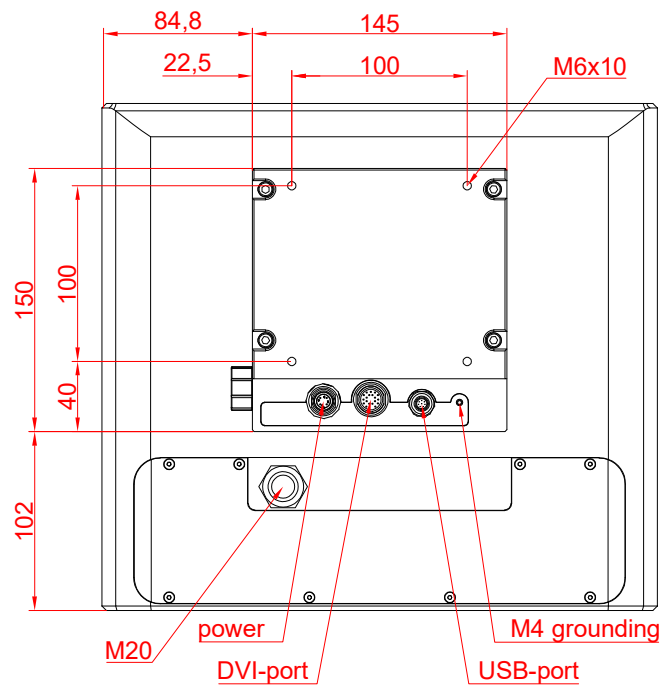

rear view

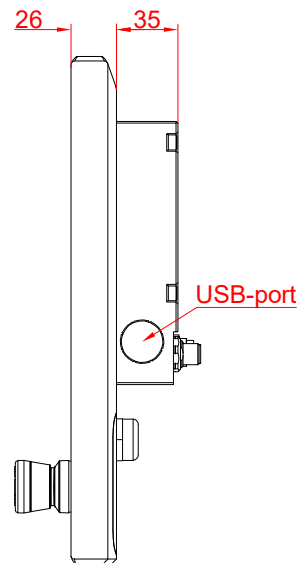

side view

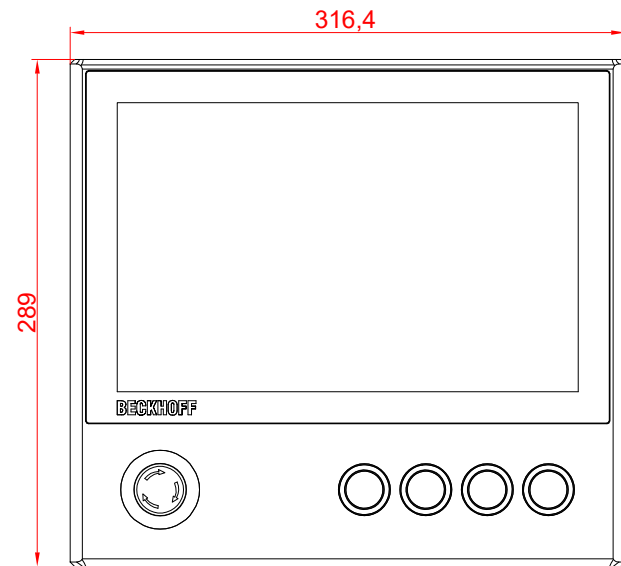

front view