

CP3918-G025-0010-M753

main dimensions and
fixing points

dimensions in mm

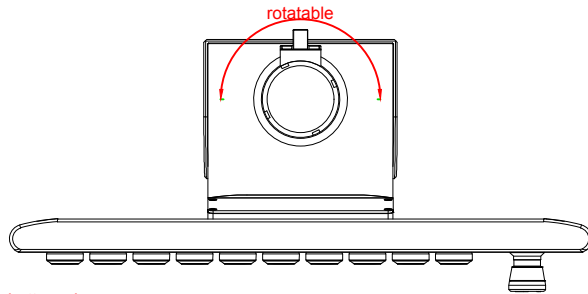

bottom view

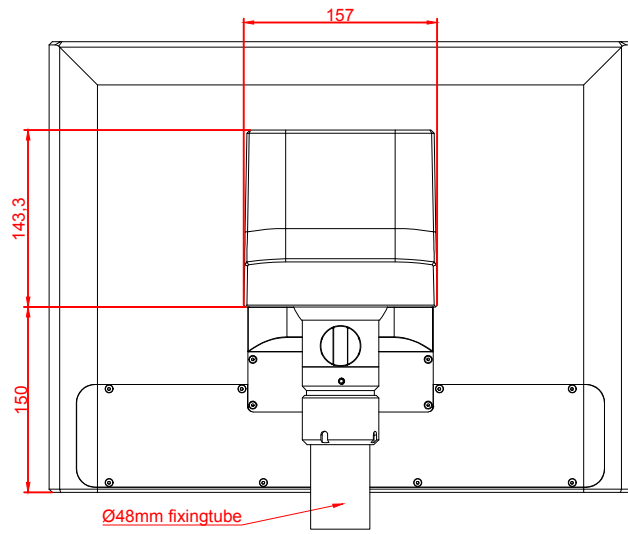
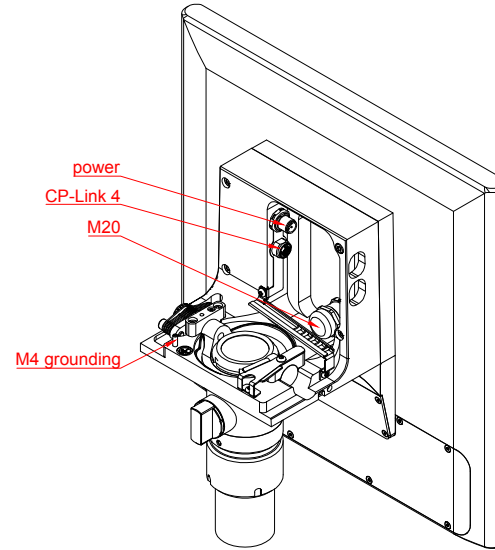

rear view

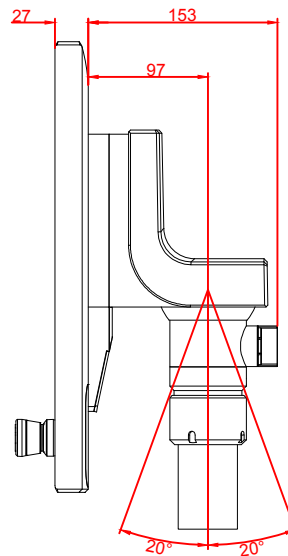

right view

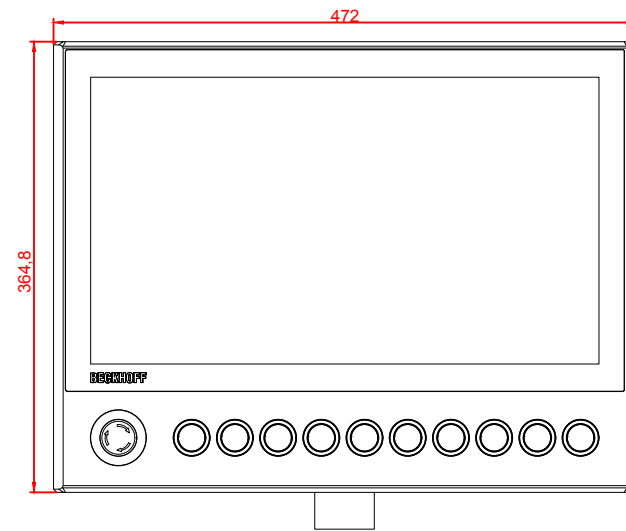

front view