

CP3918-0000  
with  
C9000-M390  
C9900-E274

main dimensions and  
fixing points

dimensions in mm

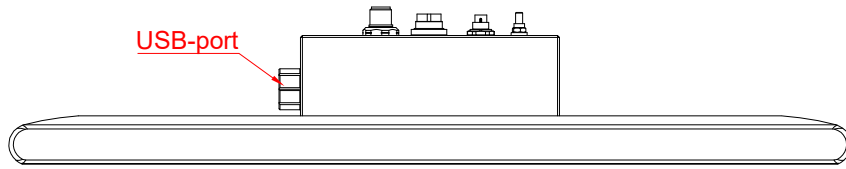

bottom view

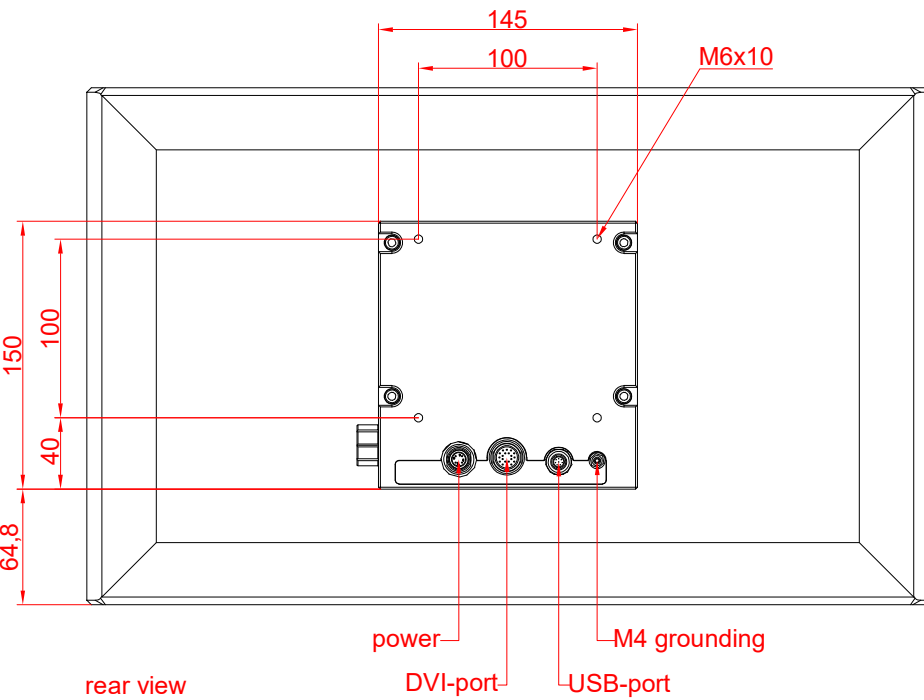
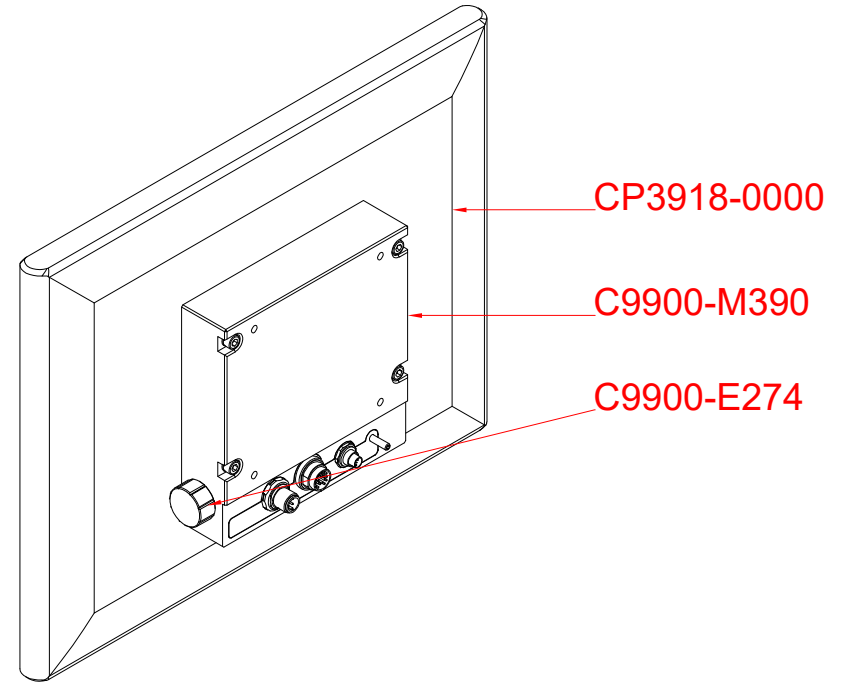

rear view

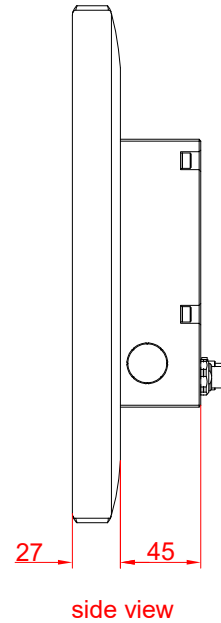

side view

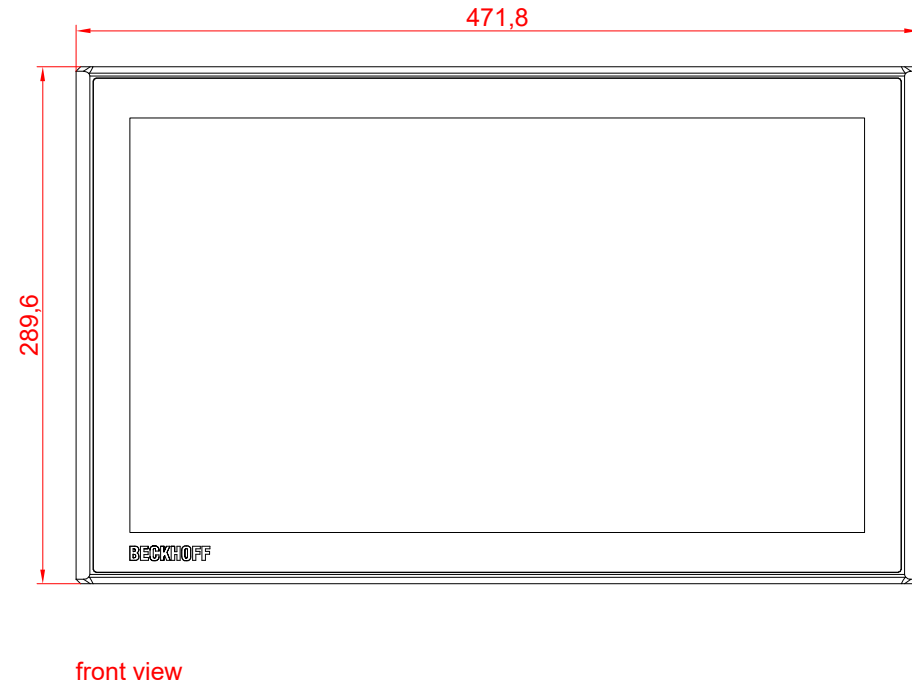

front view