

bottom view

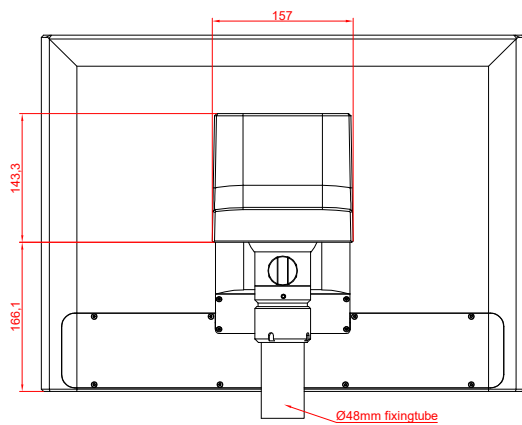

rear view

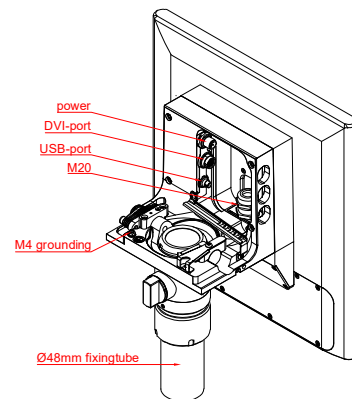
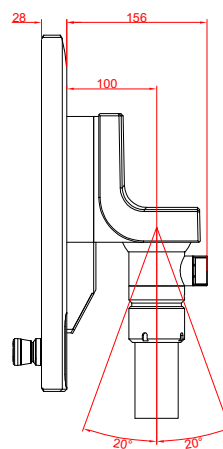

side view

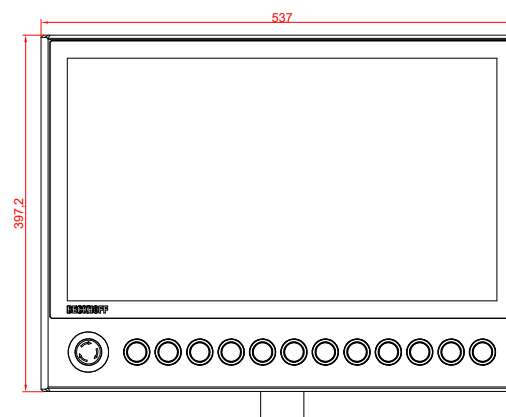

front view

CP3921-0000  
with  
C9900-G028  
C9900-M753

main dimensions and  
fixing points

dimensions in mm

