

bottom view

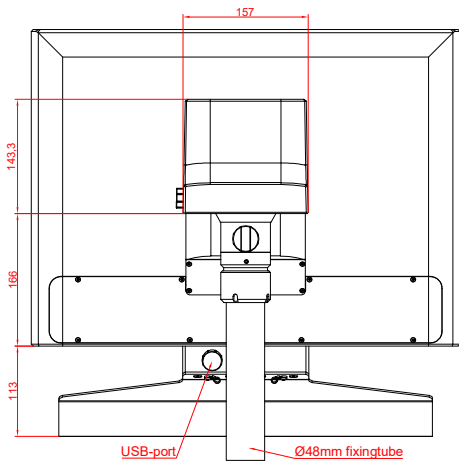

rear view

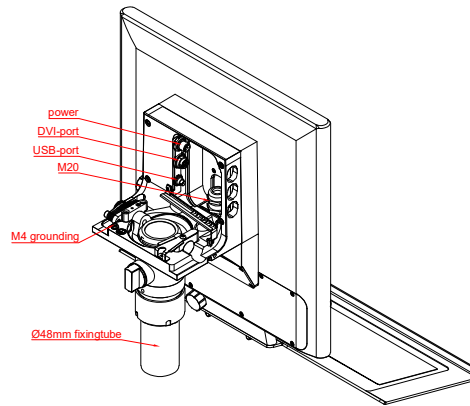
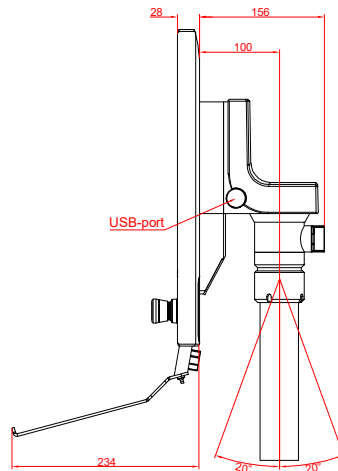

side view

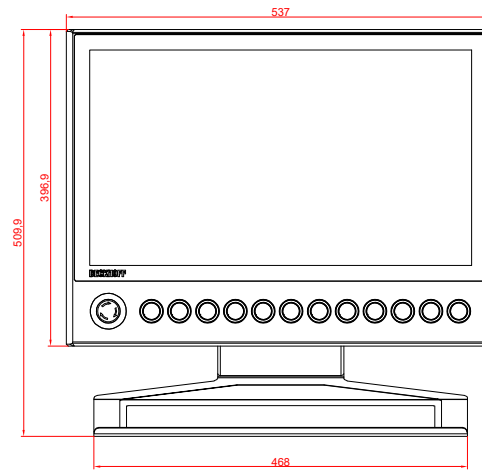

front view

CP3921-0000
with
C9900-G028
C9900-M753
C9900-E274
C9900-M406

main dimensions and
fixing points

dimensions in mm

