

CP3924-0000
with
C9900-M575

main dimensions and
fixing points

dimensions in mm

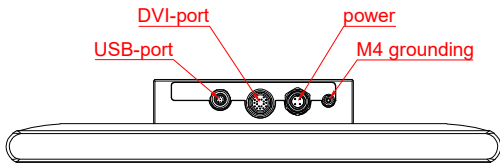
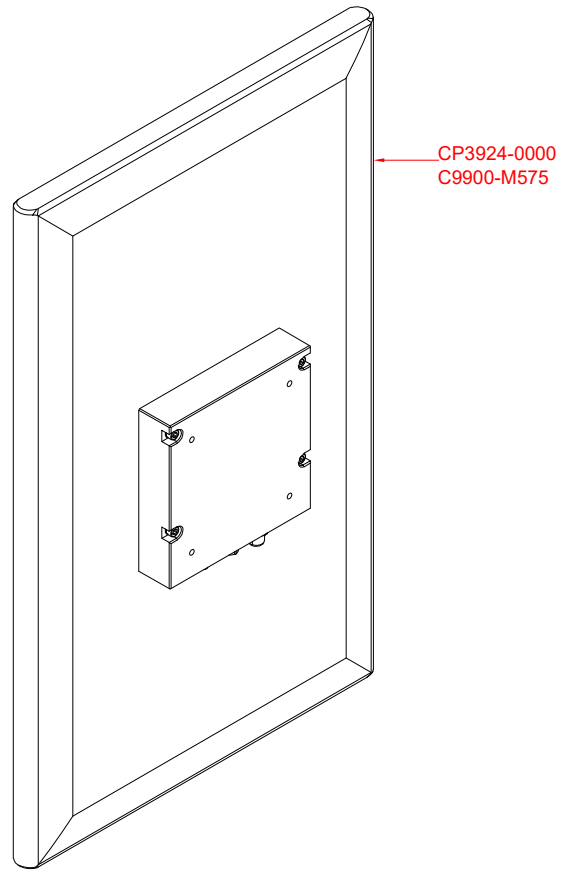

bottom view

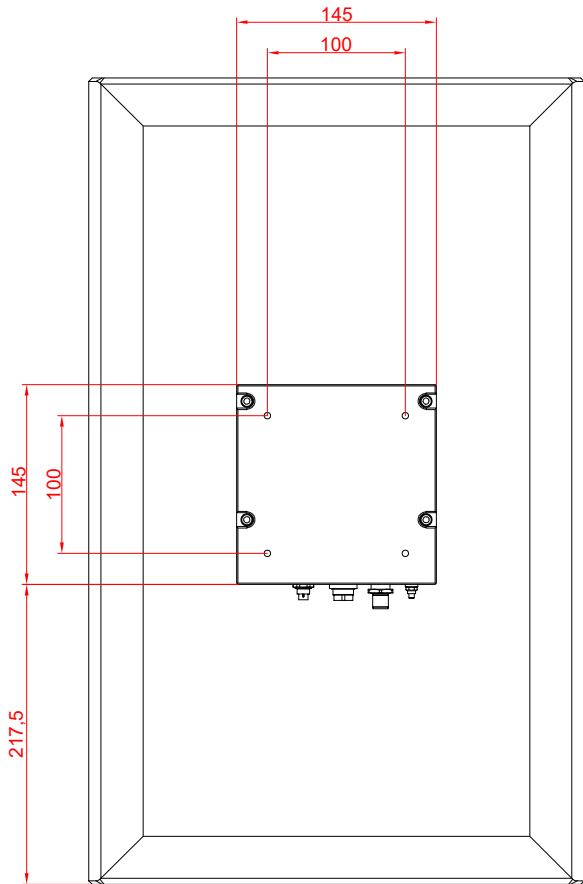

rear view



side view

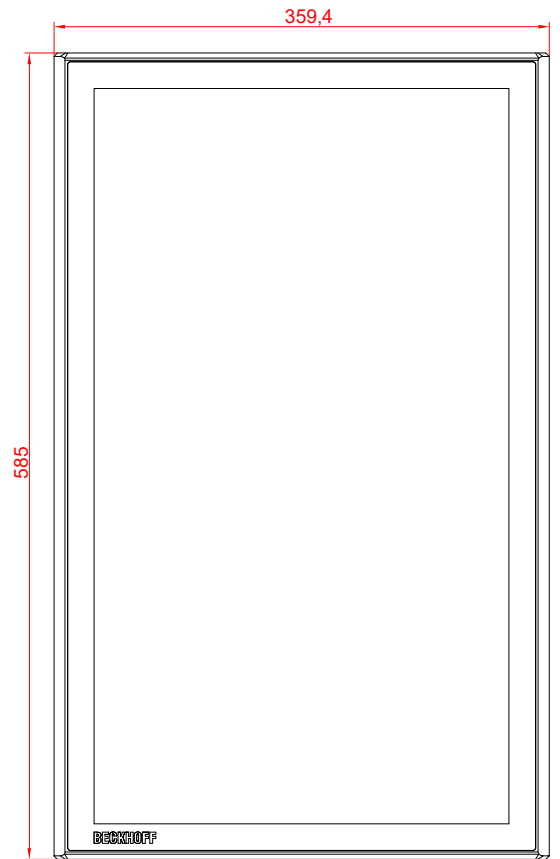

front view