

bottom view

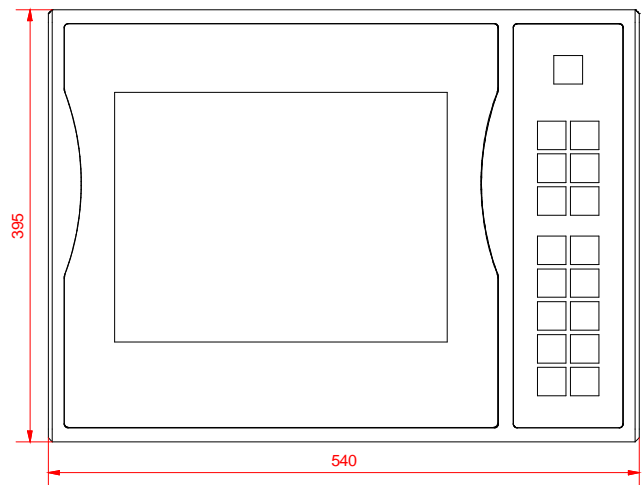

front view

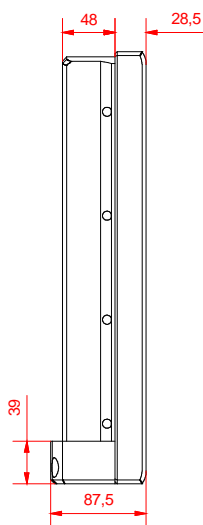

left view

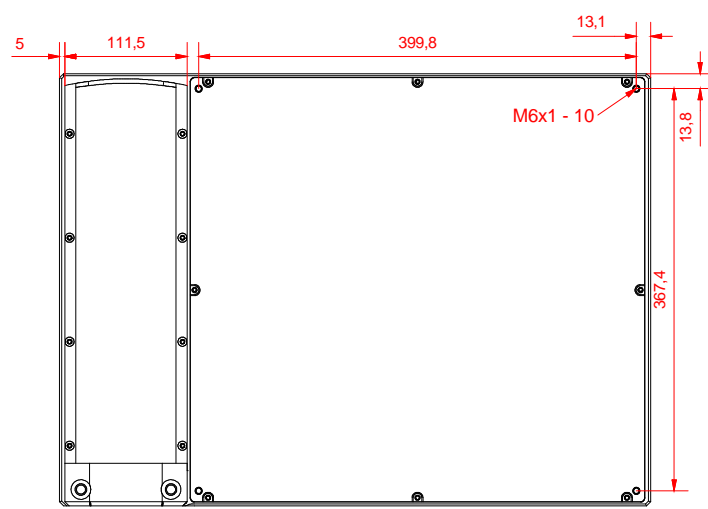

rear view

CP7012 - 0000 - E657

arm adapter for
Rolec - Tara - suspension adaption
146.025.019

main dimensions and
fixing points

dimensions in mm

