

bottom view

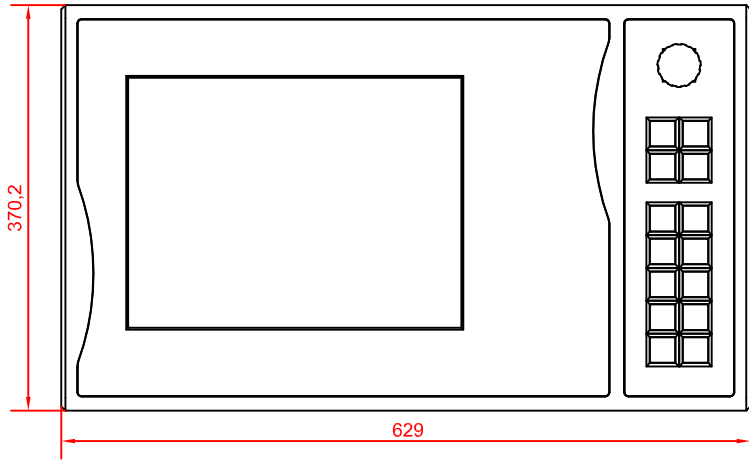

front view

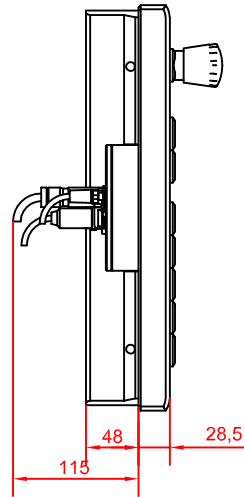

left view

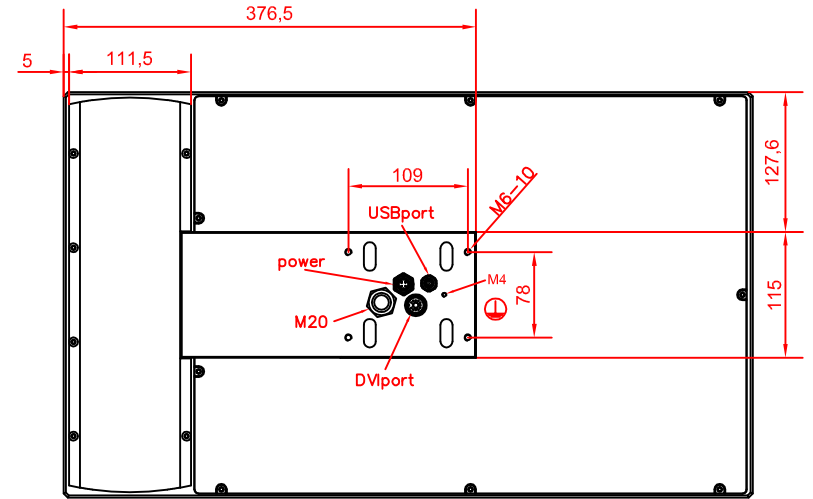

rear view

CP7822-0000-E767  
arm adapter for  
Rolec - Tara - suspension adaption  
146.025.019

main dimensions and  
fixing points

dimensions in mm

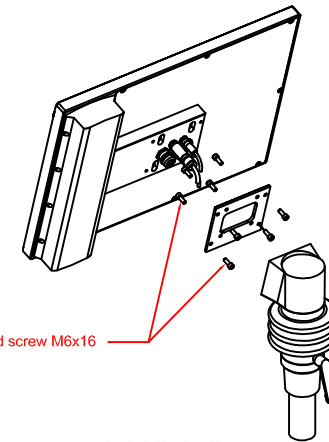

149.025.013